

A Few Words First

Courtesy – Please mute your phone (*6 toggle).

Upcoming Chapter Meetings:

- May 10, Developing the Next Generation of Systems Engineering Leaders
Dawn Schaible, NASA Deputy Chief Engineer
- May 19 Tutorial, Agile Risk Management
Rick Dove, Paradigm Shift International
Registration is Open – www.incose.org/enchantment in Library/Tutorials
- Jun 14, Defining “System” – a Comprehensive Approach
Regina Griego, Sandia National Labs
- Jul ??, Summer Social, TBD

Aug 21-25, International Systems Safety Conference, **Albuquerque**, NM
<http://issc2017.system-safety.org>

Oct 06-07, 2017 Socorro Systems Summit at NM Tech

CSEP Courses by *Certification Training International*:

Course details | Course brochure

2017 Course Schedule (**close by**, but many more locations and dates):

May 1-5	Denver, CO
Aug 7-11	Austin, TX
Oct 30-Nov 3	Las Vegas, NV

First slide, not recorded but retained in pdf presentation.

And Now - Introductions

Enchantment Chapter Monthly Meeting

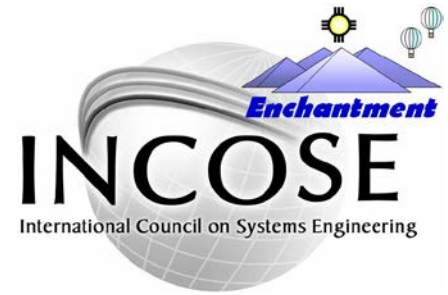

12 April 2017 – 11:45am-1:00 pm:

What the Systems Community Can Learn from ASME Work in Computational Model V&V Standardization

Bill Schindel, President, ICTT System Sciences, schindel@icct.com

Abstract: ASME teams are pioneering the generation of guidelines and standards concerning verification and validation of computational models and modeling, helping the related practitioner communities establish a shared view of this important and advancing practice. The INCOSE sister engineering society for general systems illustrates the interest of the systems community in this advance, attracting contributions to the effort, and learning from it. INCOSE has seen explosive growth in generation and use of general system models across many domains, including aerospace, automotive, medical and health care, advanced manufacturing, and infrastructure systems. As these models are consulted for managing risks and opportunities and making decisions that include safety-critical and large financial issues, questions of trust in the models themselves rapidly become critical. In the systems community, those questions are only part of the rapidly evolving context, which also includes the rise of standards-based systems modeling languages, advanced modeling tools, and integrated executable models and simulations as a part of the overall systems model fabric. The ASME efforts in model V&V, although originally targeting a narrower class of models, is surfacing and describing many principles of model V&V that can also be made to apply to more general classes of system models. This talk reflects the perspective of INCOSE Model-Based Systems Engineering community leadership, concerning the need for V&V of systems models in general, and the opportunity to learn from and contribute to the related ASME standards committee efforts.

Download slides today-only from GlobalMeetSeven file library or
anytime from the Library at www.incose.org/enchantment

NOTE: This meeting will be recorded

Today's Presentation

Things to Think About

How can this be applied in your work environment?

What did you hear that will influence your thinking?

What is your take away from this presentation?

Speaker Bio



William D. (Bill) Schindel chairs the Model-Based Systems Engineering Patterns Working Group of the INCOSE/OMG MBSE Initiative.

An ASME member, he is part of the ASME VV50 standards team's effort to describe the verification and validation of targeted models.

Schindel is president of ICTT System Sciences, and has practiced systems engineering for over thirty years, across multiple industry domains.

He earned the B.S. and M.S. degrees in mathematics, is an INCOSE Fellow, and an INCOSE Certified Systems Engineering Professional.

What the Systems Community Can Learn from ASME Work in Computational Model V&V Standardization

Model Verification, Validation, and
Uncertainty Quantification

Bill Schindel, ICTT System Sciences
schindel@icctt.com

V&V of Models,
Per Emerging ASME Model V&V Standards

Does the Model adequately describe what it is intended to describe?

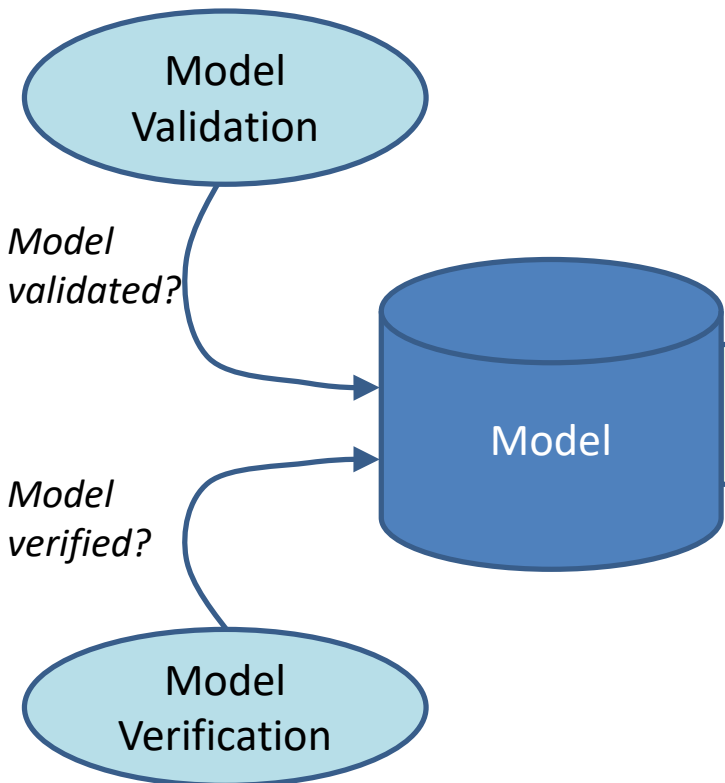

Does the Model implementation adequately represent what the Model says?

V&V of Systems,
Per ISO 15288 & INCOSE Handbook

Do the System Requirements describe what stakeholders need?

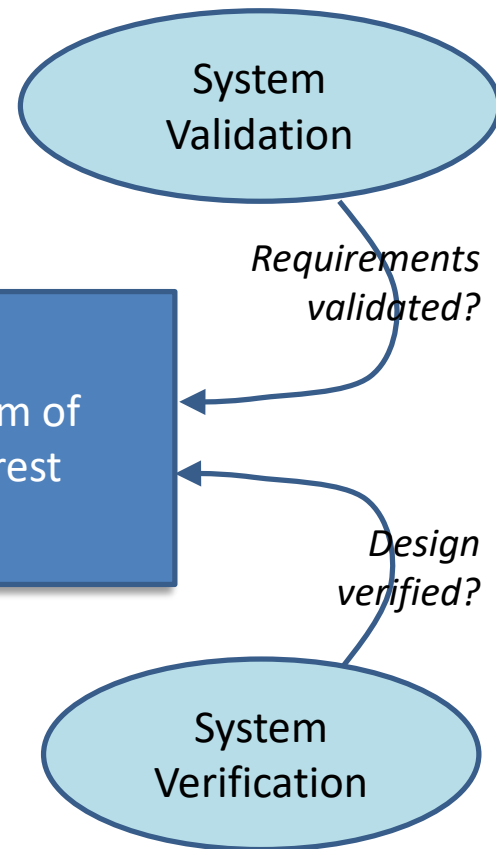

Does the System Design define a solution meeting the System Requirements?

The idea in a nutshell . . .

Contents

- Models: Enthusiasm, purpose, trust
- Kinds of models
- V&V of systems vs. V&V of models
- Scientific heritage
- Related ASME activities and resources
- Modeling the model situation and life cycle
- Maturity in use of models
- Community activities
- What you can do

- References

Model enthusiasm

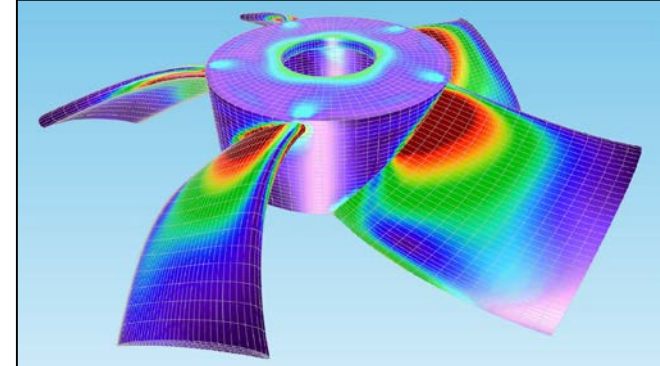
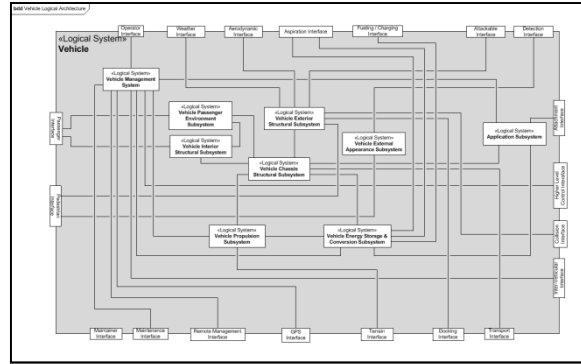
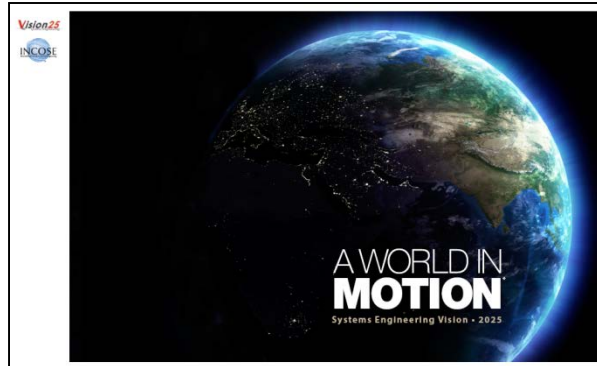

The INCOSE systems community has shown growing enthusiasm for “engineering with models” of all sorts:

- Historical tradition of math-physics engineering models
- A World in Motion: INCOSE Vision 2025
- Growth of the INCOSE IW MBSE Workshop
- Growth in systems engineers in modeling classes
- INCOSE Board of Directors’ objective to accelerate transformation of SE to a model-based discipline
- Joint INCOSE activities with NAFEMS

Models for what purposes?

System of Innovation (SOI) Pattern Logical Architecture

(Adapted from ISO/IEC 15288:2015)

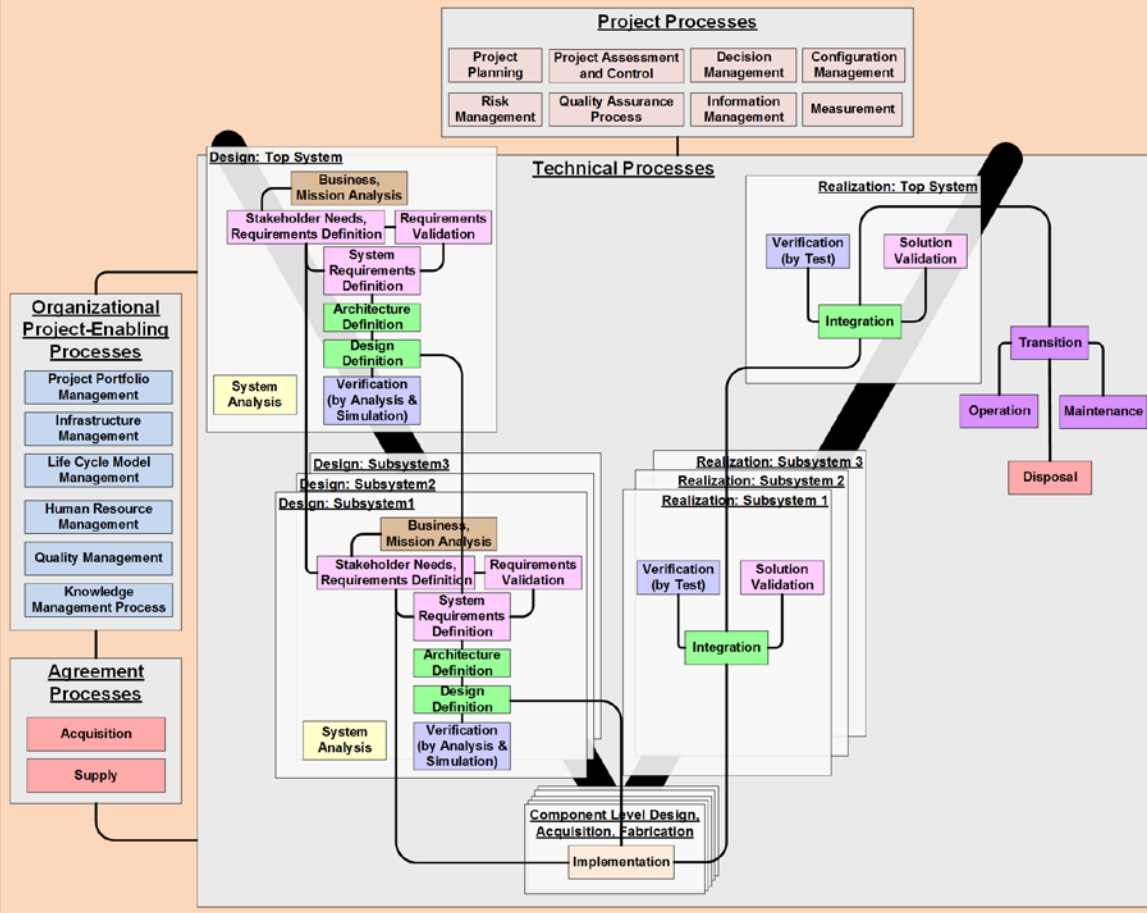

Potentially for any ISO 15288 processes:

- If there is a net benefit . . .
- Some more obvious than others.
- The INCOSE MBE Transformation is using ISO 15288 framework as an aid to migration planning and assessment.

If we expect to use models to support critical decisions, then we are placing increased trust in models:

- Critical financial, other business decisions
- Human life safety
- Societal impacts
- Extending human capability

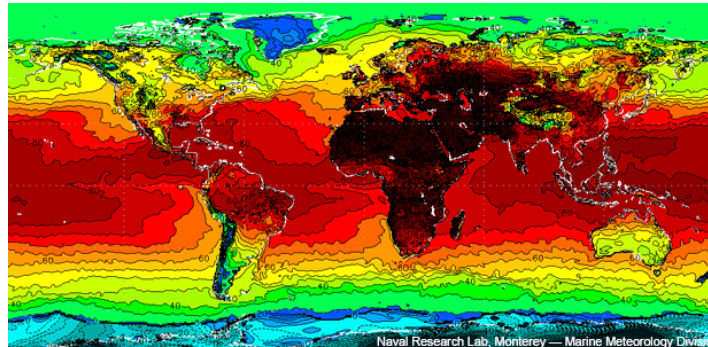

- This talk is about efforts to characterize the structure of that trust (confidence in models) and manage it:
 - The Validation, Verification, and Uncertainty Quantification (VVUQ) of the models themselves.

Kinds of models

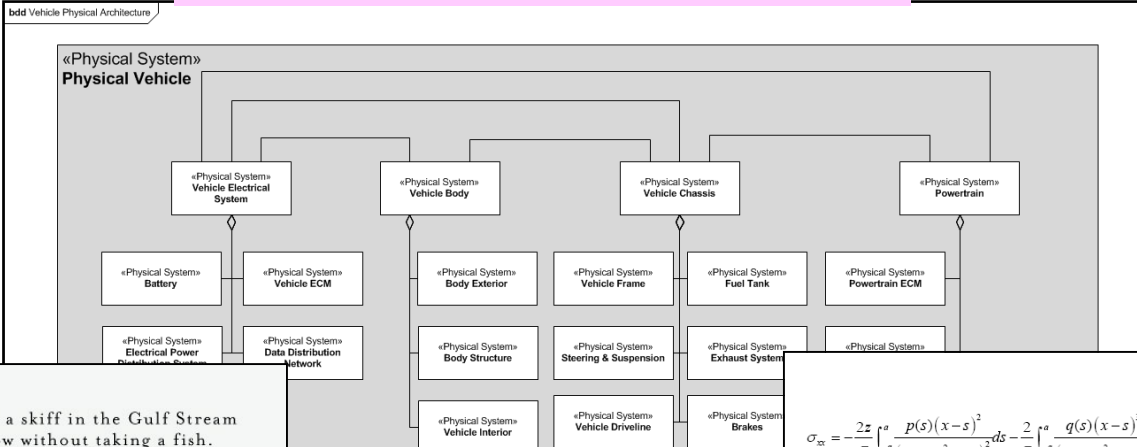

He was an old man who fished alone in a skiff in the Gulf Stream and he had gone eighty-four days now without taking a fish.

Hemingway, *The Old Man and the Sea*

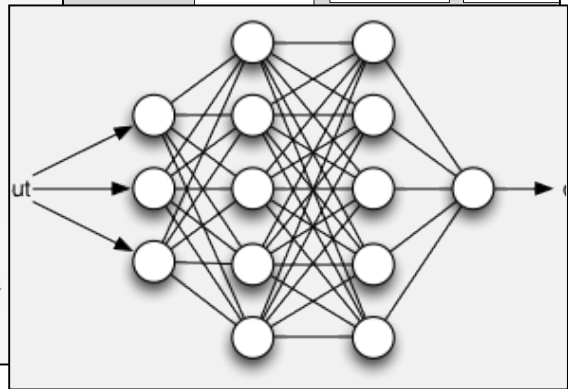
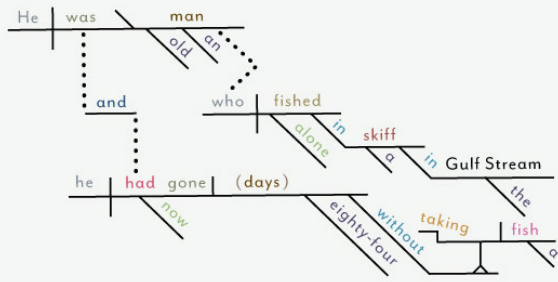

$$\sigma_{xx} = -\frac{2z}{\pi} \int_{-a}^a \frac{p(s)(x-s)^2}{((x-s)^2+z^2)^2} ds - \frac{2}{\pi} \int_{-a}^a \frac{q(s)(x-s)^3}{((x-s)^2+z^2)^2} ds$$

$$\sigma_{zz} = -\frac{2z^3}{\pi} \int_{-a}^a \frac{p(s)}{((x-s)^2+z^2)^2} ds - \frac{2z^2}{\pi} \int_{-a}^a \frac{q(s)(x-s)}{((x-s)^2+z^2)^2} ds$$

$$\tau_{xz} = -\frac{2z^2}{\pi} \int_{-a}^a \frac{p(s)(x-s)}{((x-s)^2+z^2)^2} ds - \frac{2z}{\pi} \int_{-a}^a \frac{q(s)(x-s)^2}{((x-s)^2+z^2)^2} ds$$

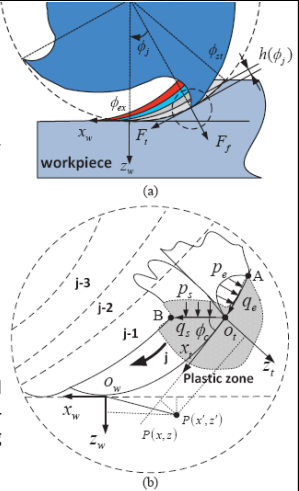

From: Huang, Zhanga, Dinga, "An analytical model of residual stress for flank milling of Ti-6Al-4V", 15th CIRP Conference on Modelling of Machining Operations

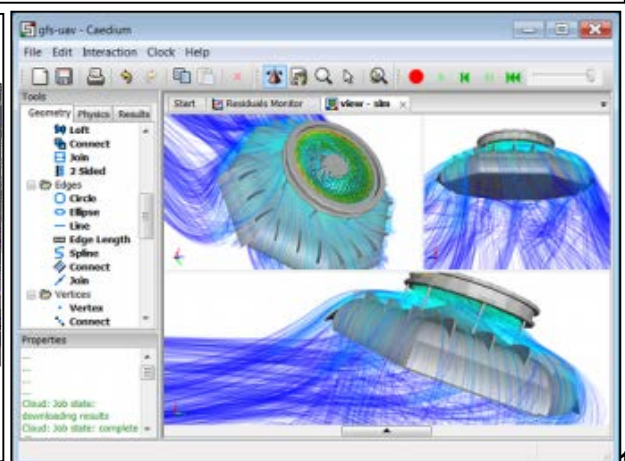
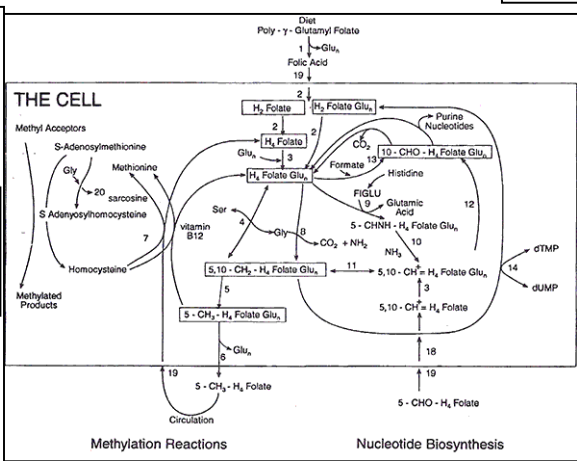
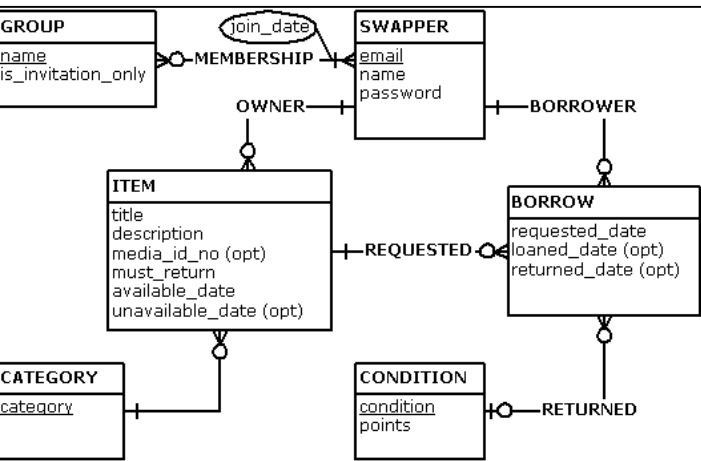

Kinds of models

For purposes of this talk, by “Model” we mean an explicit data structure that effectively describes, to a Model Interpreter, aspects of a Modeled Thing useful for the purposes of engineering or science:

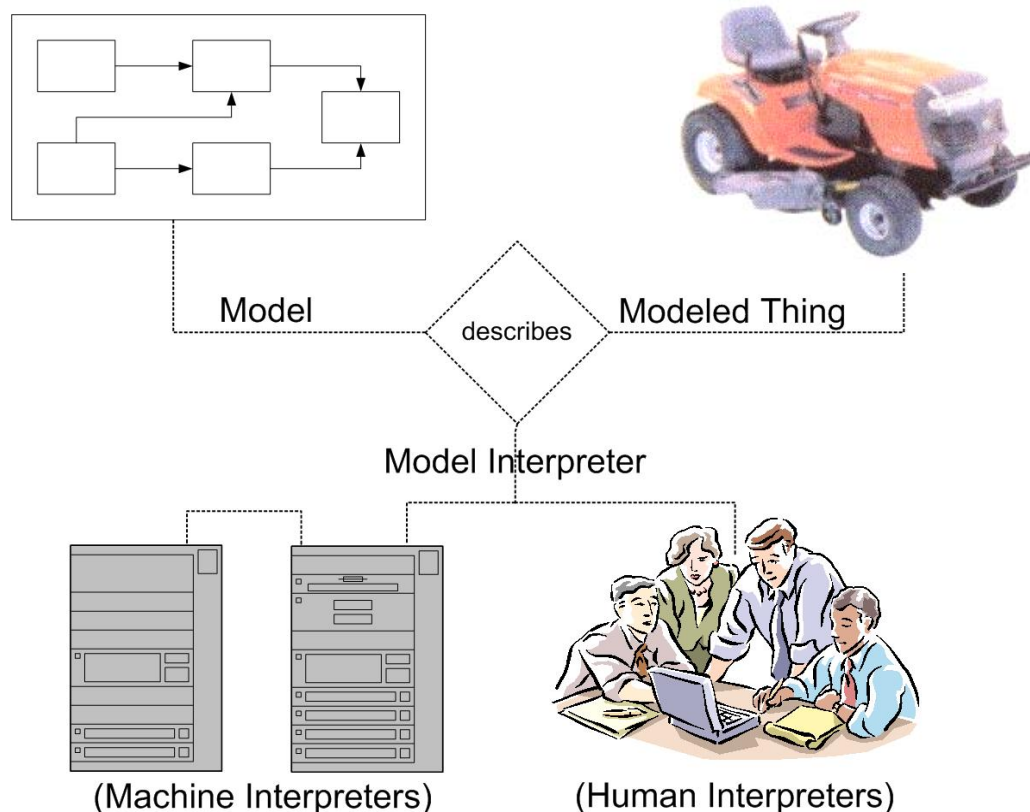

Kinds of models

Even within that restricted notion of “Model”, current engineering practice may include an evolving mix of different kinds of models, known by differing names, sometimes for the same thing, sometimes for the same things:

- “System models”, “MBSE models”
- “Physics-based models”
- “Data-driven models”
- “Executable” or “Computational” models (simulations)
- Other types or other names for the same types
- Two above refer in part to how the models are developed . . .

Physics-Based Model

- Predicts the external behavior of the System of Interest, visible externally to the external actors with which it interacts.
- Models internal physical interactions of the System of Interest, and how they combine to cause/explain externally visible behavior.
- Model has both external predictive value and phenomena-based internal-to-external explanatory value.
- Overall model may have high dimensionality.

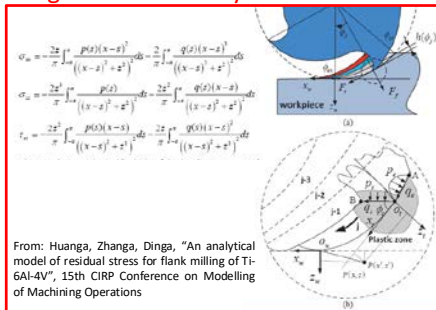

Data Driven Model

- Predicts the external behavior of the System of Interest, visible to the external actors with which it interacts.
- Model intermediate quantities may not correspond to internal or external physical parameters, but combine to adequately predict external behavior, fitting it to compressed relationships.
- Model has external predictive value, but not internal explanatory value.
- Overall model may have reduced dimensionality.

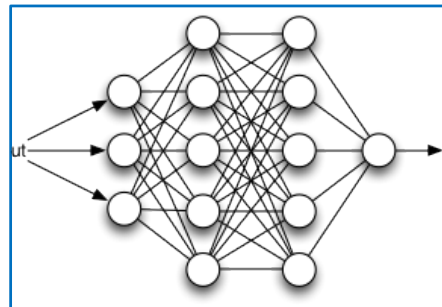

- Physical scientists and phenomena models from their disciplines can apply here.
- The hard sciences physical laws, and how they can be used to explain the externally visible behavior of the system of interest.

predicts, explains

predicts

optional

- Data scientists and their math/IT tools can apply here (data mining, pattern extraction, cognitive AI tooling).
- Tools and methods for discovery / extraction of recurring patterns of external behavior.

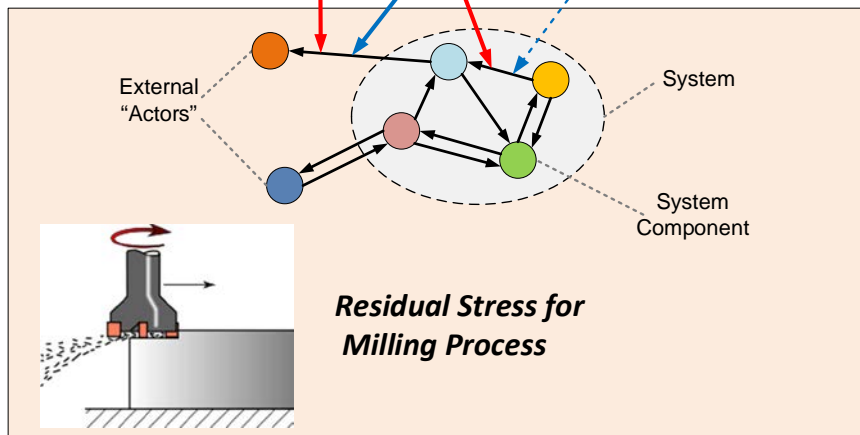

Real Target System Being Modeled

V&V of Systems versus V&V of Models

- The INCOSE systems community has a strong tradition of using the terms Verification and Validation to refer to System of Interest being engineered.
- Returning to industry efforts to characterize and manage trust in models, we find that these same two terms and ideas appear again:
 - but pointed to a different target;
 - This framework is what caused the speaker, in 2016, to join the related ASME effort;
 - Observation: There is some lack of awareness, on both the INCOSE (Systems V&V) and ASME (Model V&V) sides of the respective other side of the practice;
 - it is important to keep the related ideas clear . . .

V&V of Models, Per Emerging ASME Model V&V Standards

Does the Model adequately describe what it is intended to describe?

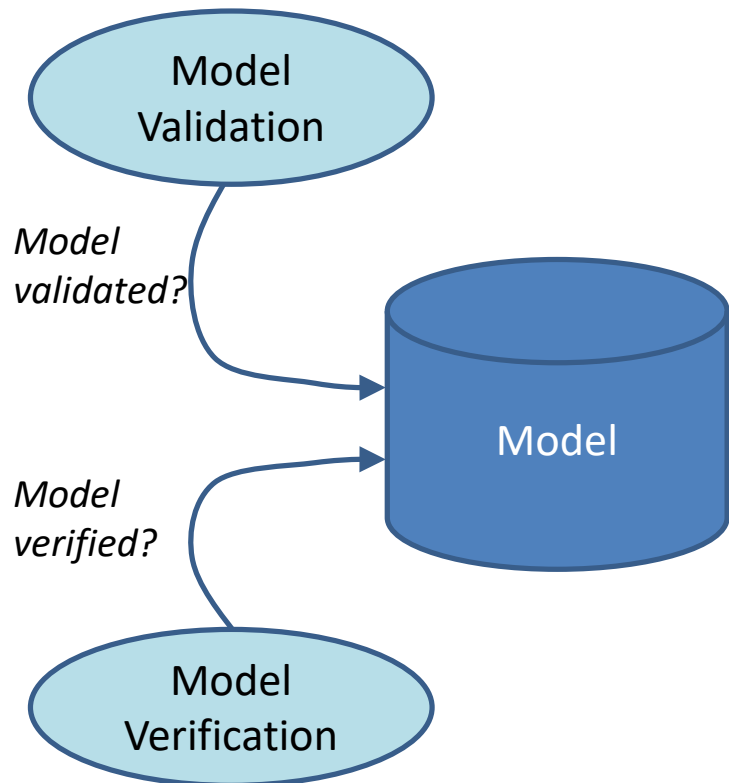

Does the Model implementation adequately represent what the Model says?

V&V of Systems, Per ISO 15288 & INCOSE Handbook

Do the System Requirements describe what stakeholders need?

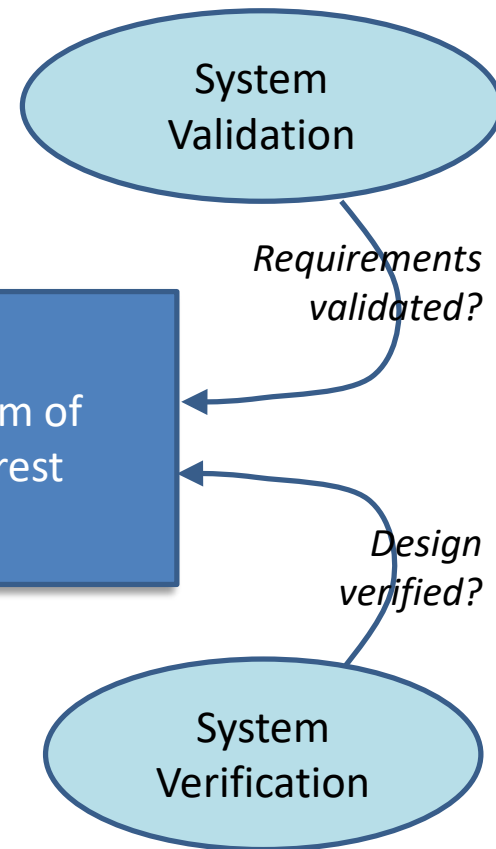

Does the System Design define a solution meeting the System Requirements?

Don't forget: A model (on the left) may be used for system verification or validation (on the right!)

Scientific heritage

- This activity is recapitulating the scientific heritage of models and related feedback correction loops (learning):
 - For thousands of years, humans recognized “external patterns” --models that could be used to predict similar future behavior, but lacked explanatory content (e.g., movement of the Sun, Moon, Stars, Planets)—these observed patterns were subject to validation.
 - During the last 300 years, these were joined by explanatory patterns—models that additionally explain external behavior as arriving from internal interactions—these theoretical models were subject to verification.
 - In both, learning is represented by improving models.

Scientific heritage

- Eventual flowering of the physical sciences depended upon the emergence of strong enough underlying model constructs (of math, physics) to better represent Nature.
- Specifically, the System Phenomenon:

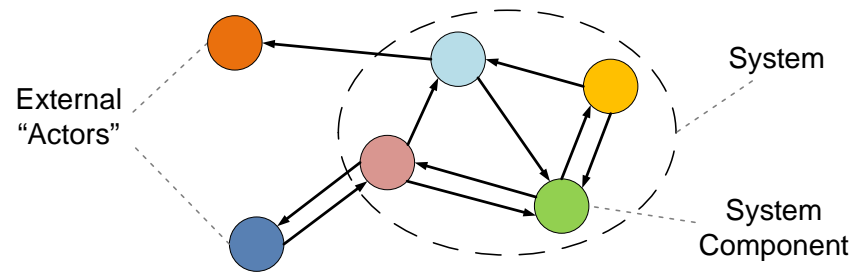

A traditional view

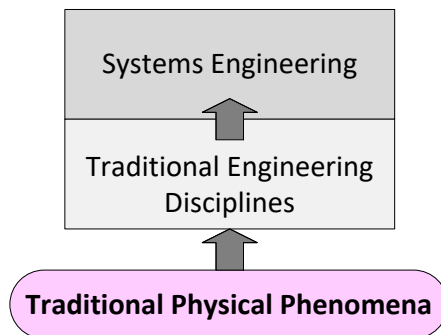

Our view

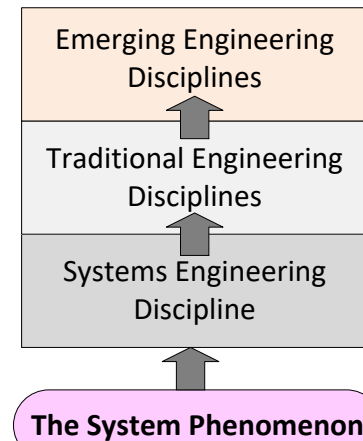

For general systems models, this has likewise meant that we needed to strengthen ideas like prose requirements and interaction models in order to gain full advantage of MBSE:

Meta-model for Model-Based Systems Engineering (MBSE)

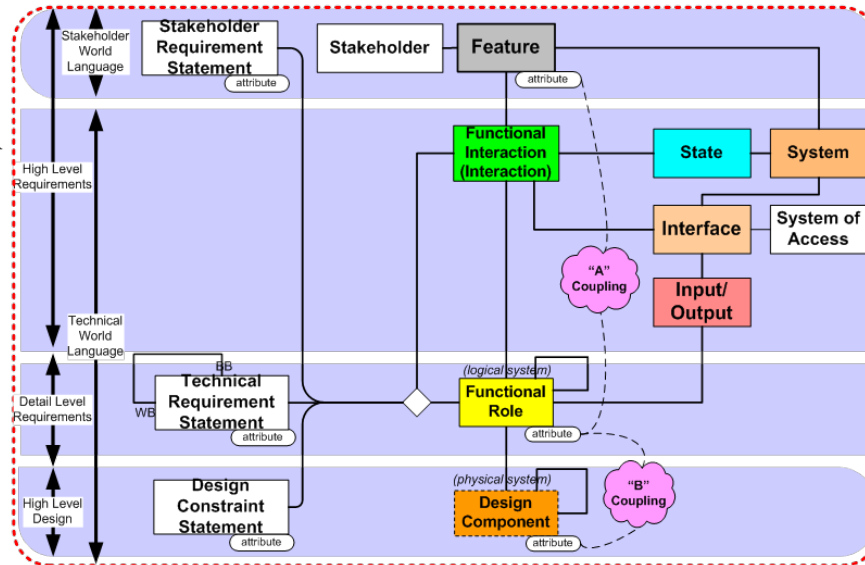

26th Annual INCOSE International Symposium (IS 2016)
Edinburgh, Scotland, UK, July 18-21, 2016

Got Phenomena? Science-Based Disciplines for Emerging Systems Challenges

Bill Schindel
ICTT System Sciences
schindel@sctt.com

Copyright © 2015 by Bill Schindel. Published and used by INCOSE with permission.

Abstract. Engineering disciplines (ME, EE, CE, ChE) sometimes argue their fields have “real physical phenomena”, “hard science” based laws, and first principles, claiming Systems Engineering lacks equivalent phenomenological foundation. We argue the opposite, and how replanting systems engineering in MBSE/PBSE supports emergence of new hard sciences and phenomena-based domain disciplines.

Supporting this perspective is the System Phenomenon, wellspring of engineering opportunities and challenges. Governed by Hamilton’s Principle, it is a traditional path for derivation of equations of motion on physical laws of so-called “fundamental” physical

INCOSE 2005 Symposium “Best Paper” Award in Modeling and Tools

Requirements Statements Are Transfer Functions: An Insight from Model-Based Systems Engineering

William D. Schindel
ICTT, Inc., and System Sciences, LLC
100 East Campus Drive, Terre Haute, IN 47802
812-232-2062 schindel@icct.com

Copyright © 2005 by William D. Schindel. Published and used by INCOSE with permission.

Abstract. Traditional systems engineering pays attention to careful composition of prose requirements statements. Even so, prose appears less than what is needed to advance the art of systems engineering into a theoretically-based engineering discipline comparable to Electrical, Mechanical, or Chemical Engineering. Ask three people to read a set of prose requirements statements, and a universal experience is that there will be three different impressions of their meaning. The rise of Model-Based Systems Engineering might suggest the demise of prose

Related ASME activities and resources



- ASME, has an active set of teams writing guidelines and standards on the Verification and Validation of Computational Models.
 - Inspired by the proliferation of computational models (FEA, CFD, Thermal, Stress/Strain, etc.)
 - It could fairly be said that this historical background means that effort was not focused on what most systems engineers would call “system models”
- Also conducts annual Symposium on Validation and Verification of Computational Models, in May.
- To participate in this work, in 2016 the speaker joined the ASME VV50 Committee:
 - With the idea that the framework ASME set as foundation could apply well to systems level models; and . . .
 - with a pre-existing belief that system level models are not as different from discipline-specific physics models as believed by systems community.
- Also invited sub-team leader Joe Hightower (Boeing) to address the INCOSE IW2017 MBSE Workshop, on our related ASME activity.

ASME Verification & Validation Standards Committee

- V&V 10: Verification & Validation in Computational Solid Dynamics
 - V&V20: Verification & Validation in Computational Fluid Dynamics and Heat Transfer
 - V&V 30: Verification and Validation in Computational Simulation of Nuclear System Thermal Fluids Behavior
 - V&V 40: Verification and Validation in Computational Modeling of Medical Devices
 - V&V 50: Verification & Validation of Computational Modeling for Advanced Manufacturing
 - V&V 60: Verification and Validation in Modeling and Simulation in Energy Systems and Applications
- <https://cstools.asme.org/cconnect/CommitteePages.cfm?Committee=100003367>

Modeling the Model Situation and Life Cycle: We are applying the System of Innovation Pattern (*)

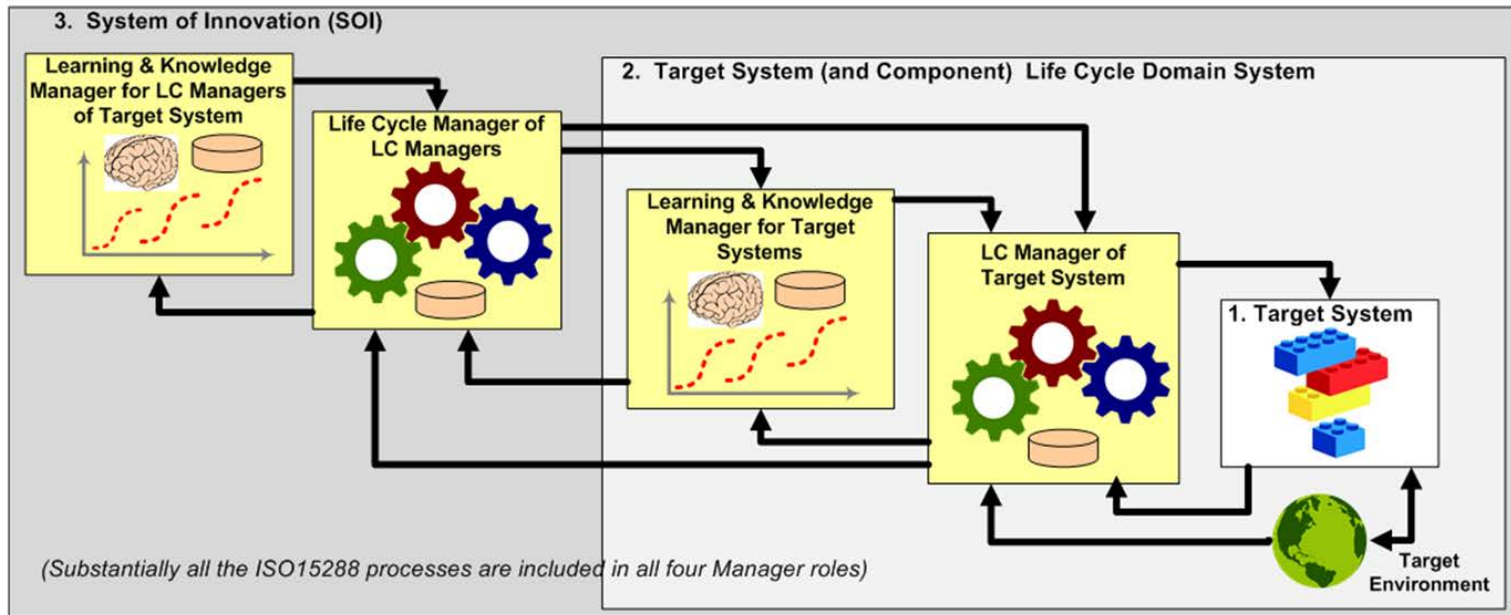

- System 1: Target system of interest, to be engineered or improved.
- System 2: The environment of (interacting with) S1, including all the life cycle management systems of S1, including learning about S1.
- System 3: The life cycle management systems for S2, including learning about S2.

(*) used in the INCOSE Agile SE Life Cycle Model Discovery Project

We are using the System of Innovation Pattern

Model (of System 1),
to be Validated & Verified

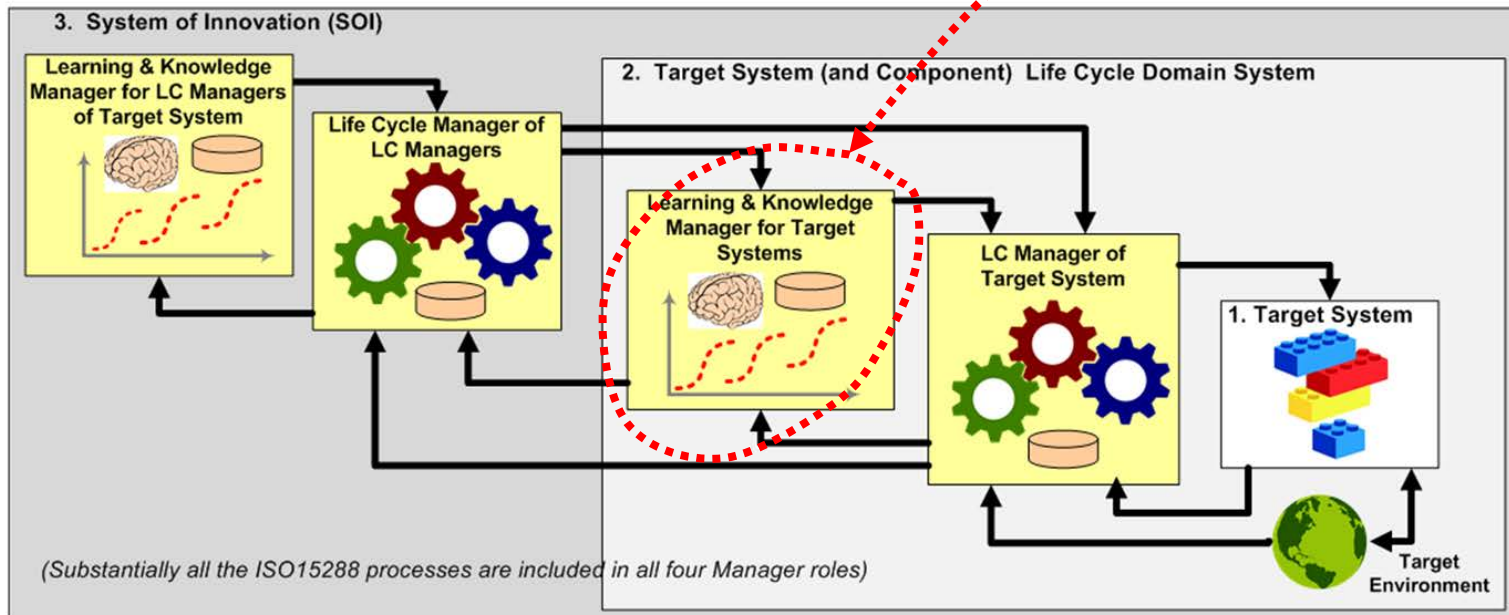

- System 1: Target system of interest, to be engineered or improved.
- System 2: The environment of (interacting with) S1, including all the life cycle management systems of S1, including learning about S1.
- System 3: The life cycle management systems for S2, including learning about S2.

Model 2 (of System 2)
Describing Model 1
Validation & Verification

Model 1 (of System 1),
to be Validated & Verified

We are using the System of Innovation Pattern

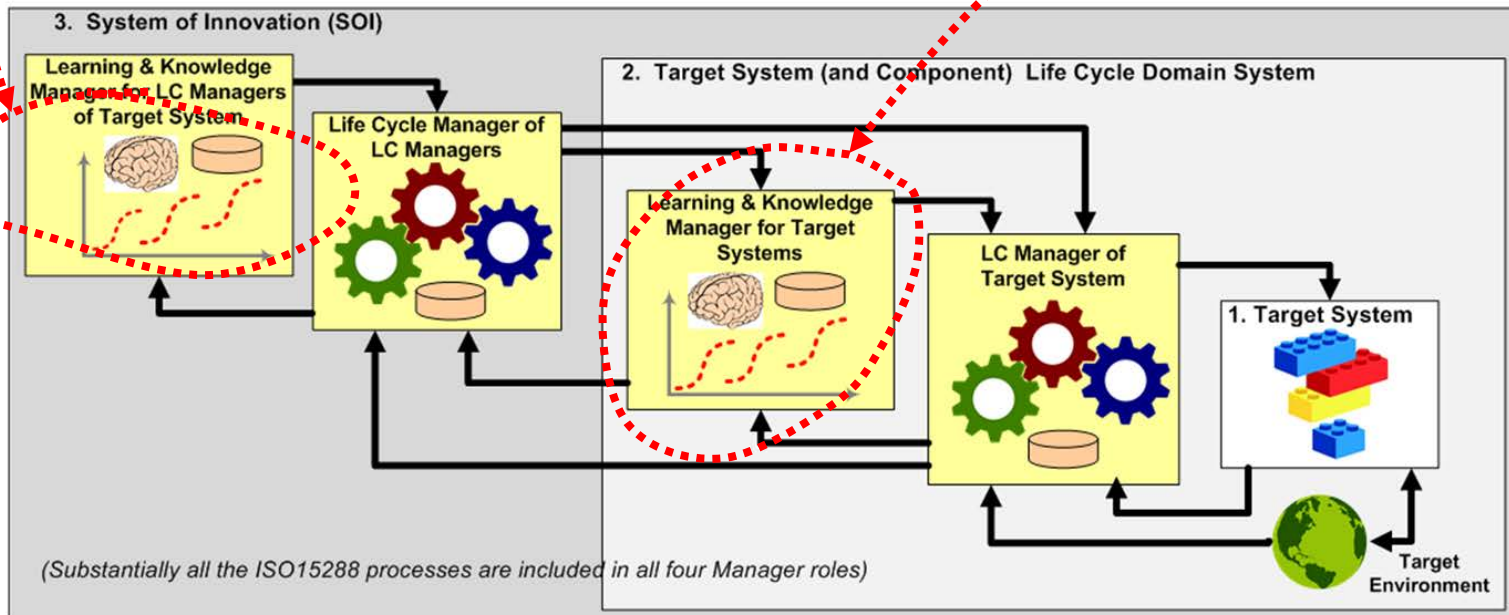

- System 1: Target system of interest, to be engineered or improved.
- System 2: The environment of (interacting with) S1, including all the life cycle management systems of S1, including learning about S1.
- System 3: The life cycle management systems for S2, including learning about S2.

System 3 (ASME Project)

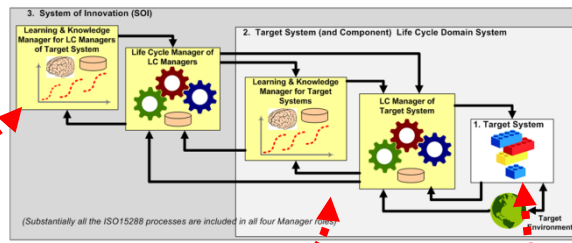

System 2

System 1

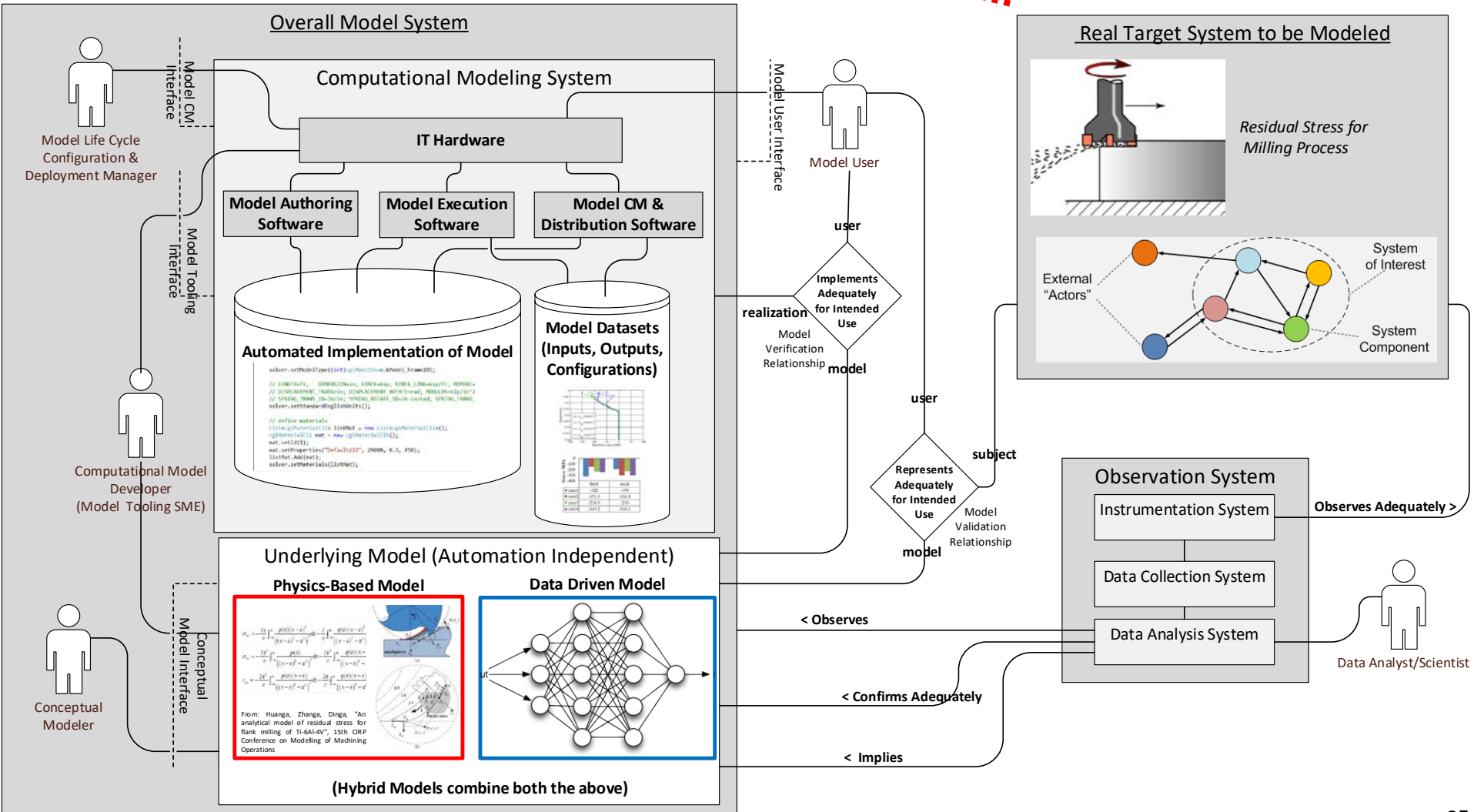

Model V&V: We are modeling the learning aspect of System 2 (key to adaptability, agility)

- The Overall Model System is itself being modeled, covering the Life Cycle for a Model.
- Beginning with the Requirements for a Model:
 - These form the foundation for the model validation and verification that follow.
 - Includes many types of models, covering Physics-Based and Data-Driven Models
- The Requirements for a Model include:
 - Model System Stakeholder Requirements
 - Model System Technical Requirements

Model Stakeholder Features (1/2)

Feature Group	Feature Name	Feature Definition	Feature Attribute	Attribute Definition	Feature Stakeholder						Model Type			
					Mdl User	Mdl Owner	Mdl Maintainer	Regulator	Supply Chain			Physics Based	Data Driven	
Model Identity and Focus	Modeled System of Interest	Identifies the type of system this model describes.	System of Interest	Name of system of interest, or class of systems of interest	X	X		X	X					
	Modeled Environmental Domain	Identifies the type of external environmental domain(s) that this model includes.	Domain Type(s)	Name(s) of modeled domains (manufacturing, distribution, use, etc.)	X	X		X	X					
Model Content and Capability	Modeled Stakeholder Value	The capability of the model to describe fitness or value of the System of Interest, by identifying its stakeholders and modeling the related Stakeholder Features.	Stakeholder Type	Classes of covered stakeholders (may be multiple)	X	X		X	X					
	Modeled System External (Black Box) Behavior	The capability of the model to represent the objective external ("black box") technical behavior of the system, through significant interactions with its environment, based on modeled input-output exchanges through external interfaces, quantified by technical performance measures, and varying behavioral modes.			X	X		X	X					
	Fitness Couplings	The capability of the model to represent quantitative (parametric) couplings between stakeholder-valued measures of effectiveness and objective external black box behavior performance measures.			X	X		X	X					
	Explanatory Decomposition	The capability of the model to represent the decomposition of its external technical behavior, as explanatory internal ("white box") internal interactions of decomposed roles, further quantified by internal technical performance measures, and varying internal behavioral modes.			X	X		X	X					
	Model Envelope	The capability of the model to meet its Model Fidelity requirements over a stated range (envelope) of dynamical inputs, outputs, and parameter values.	Model Application Envelope			X	X	X	X	X				
	Model Configurability	The capability of the model to serve as a configurable framework, parameterized or otherwise configurable to different specific models				X	X	X	X	X				
	Validated Conceptual Model Fidelity	The validated capability of the conceptual portion of the model to represent the System of Interest, with acceptable fidelity.	Quantitative Accuracy Reference			X	X	X	X	X				
Qualitative Accuracy Reference					X	X	X	X	X					
Uncertainty Quantification (UQ) Reference					X	X	X	X	X					
Model Validation Reference					X	X	X	X	X					
The verified capability of the executable portion of the model to represent the System of Interest, with acceptable fidelity.		Quantitative Accuracy Reference				X	X	X	X	X				
		Qualitative Accuracy Reference				X	X	X	X	X				
		Uncertainty Quantification (UQ) Reference				X	X	X	X	X				
		Speed				X	X	X	X	X				
Quantization				X	X	X	X	X						
Stability				X	X	X	X	X						
Model Validation Reference				X	X	X	X	X						
Model Representation	Conceptual Model Representation	The capability of the conceptual portion of the model to represent the system of interest, using a specific type of representation.	Model Representation Type	The type of modeling language or metamodel used.	X		X	X	X					

Model Stakeholder Features (2/2)

Feature Group	Feature Name	Feature Definition	Feature Attribute	Attribute Definition	Feature Stakeholder						Model Type			
					Mdl User	Mdl Owner	Mdl Maintainer	Regulator	Supply Chain		Physics Based	Data Driven		
Model Utility	Perceived Model Value and Use	The relative level of value ascribed to the model, by those who use it for its stated purpose.	User Group Segment	The identify of using group segment (multiple)	X	X		X	X					
			Level of Annual Use	The relative level of annual use by the segment	X	X		X	X					
			Value Level	The value class associated with the model by that segment	X	X		X	X					
	Third Party Acceptance	The degree to which the model is accepted as authoritative, by third party regulators, customers, supply chains, and other entities, for its stated purpose.	Accepting Authority	The identity (may be multiple) of regulators, agencies, customers, supply chains, accepting the model	X	X		X	X					
Model Ease of Use	The perceived ease with which the model can be used, as experienced by its intended users	Perceived Model Complexity	High, Medium Low	X	X		X	X						
Model Life Cycle Management	Model Versioning and Configuration Management	The capability of the model to provide for version and configuration management.	CM Capability Type	The type(s) of CM capabilities included (may be multiple)	X	X	X	X	X					
	Managed Model Datasets	The capability of the model to include managed datasets for use as inputs, parametric characterizations, or outputs	Dataset Type	The type(s) of data sets (may be multiple)	X		X	X	X					
	Executable Model Environmental Compatibility	The capability of the model to be compatibly supported by specified information technology environment(s), indicating compatibility, portability, and interoperability.	IT Environmental Component	The type(s) of IT environments or standards supported	X	X	X	X	X					
	Model Design Life and Retirement	The capability of the model to be sustained over an indicated design life, and retired on a planned basis.	Design Life	The planned retirement date	X	X	X	X	X					
	Model Maintainability	The relative ease with which the model can be maintained over its intended life cycle and use, based on capable maintainers, availability of effective model documentation, and degree of complexity of the model	Maintenance Method				X							
	Model Deployability	The capability of the model to support deployment into service on behalf of intended users, in its original or subsequent updated versions	Deployment Method			X	X							
	Model Cost	The financial cost of the model, including development, operating, and maintenance cost	Development Cost	The cost to develop the model, including its validation and verification, to its first availability for service date	X									
			Operational Cost	The cost to execute and otherwise operate the model, in standardized execution load units	X									
			Maintenance Cost	The cost to maintain the model		X	X							
			Deployment Cost	The cost to deploy, and redeploy updates, per cycle	X	X								
Retirement Cost			The cost to retire the model from service, in a planned fashion		X									
Model Availability	The degree and timing of availability of the model for its intended use, including date of its first availability and the degree of ongoing availability thereafter.	First Availability Date		X	X	X	X	X						
		Availability Code		X	X	X	X	X						

Model Technical Requirements (sample)

Not a specification of a modeling language.
Remember it must cover all the requirements for all the types of models—FEA, etc.

- “The model shall identify all the external Domain Actors with which the subject system significantly interacts.”
- “The Model shall identify the external Input-Outputs exchanged during interactions with Domain Actors, and the external Interfaces through which they are exchanged.”
- “The model shall identify and define all the types and instances of Stakeholders with a stake in the System of Interest.”
- “For each Stakeholder, the model shall identify and define all the Stakeholder Features of the System of Interest, representing packages of stakeholder value or fitness for intended use of the System of Interest.”
- “For each identified Stakeholder Feature, the model shall identify and define all the Feature Attributes that parameterize or quantify the degree or type of value or fitness.”
- “The model shall identify the different modes (states) of the system of interest that are significant to the intended use of the model.”
- “The model shall identify the possible (state) transitions between those system modes.”
- “For each of its modeled modes (states), the model shall identify which external interactions the system of interest can have with its environmental actors, from the list of possible interactions.”

The S*Metamodel is first of all helping us describe the framework for Requirements on Models, as foundation of ability to subsequently validate and verify those models.

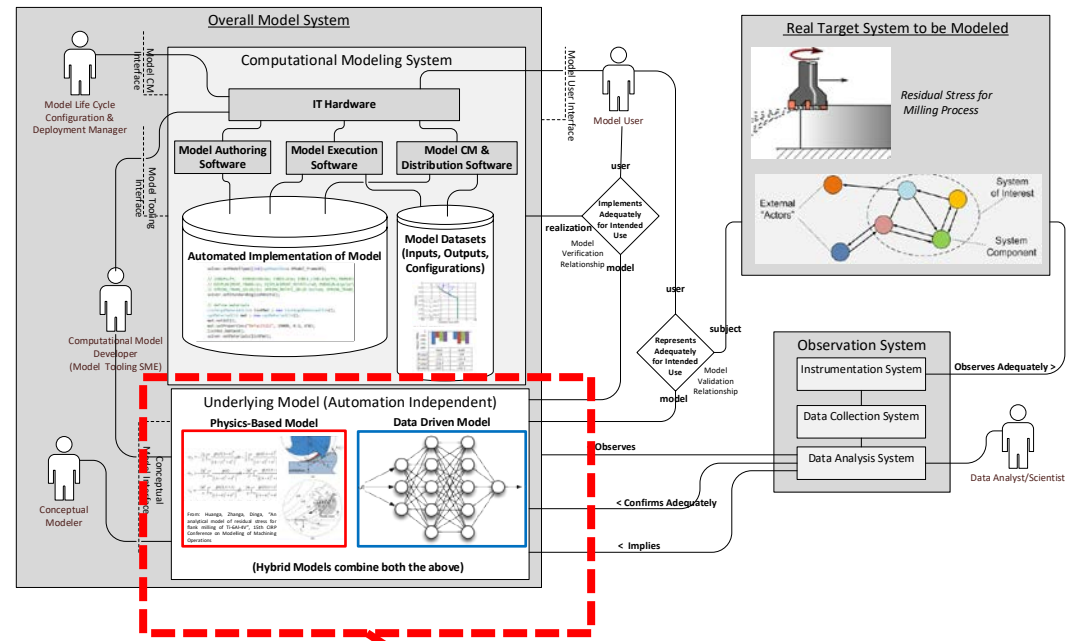

S*Metamodel for Model-Based Systems Engineering (MBSE)

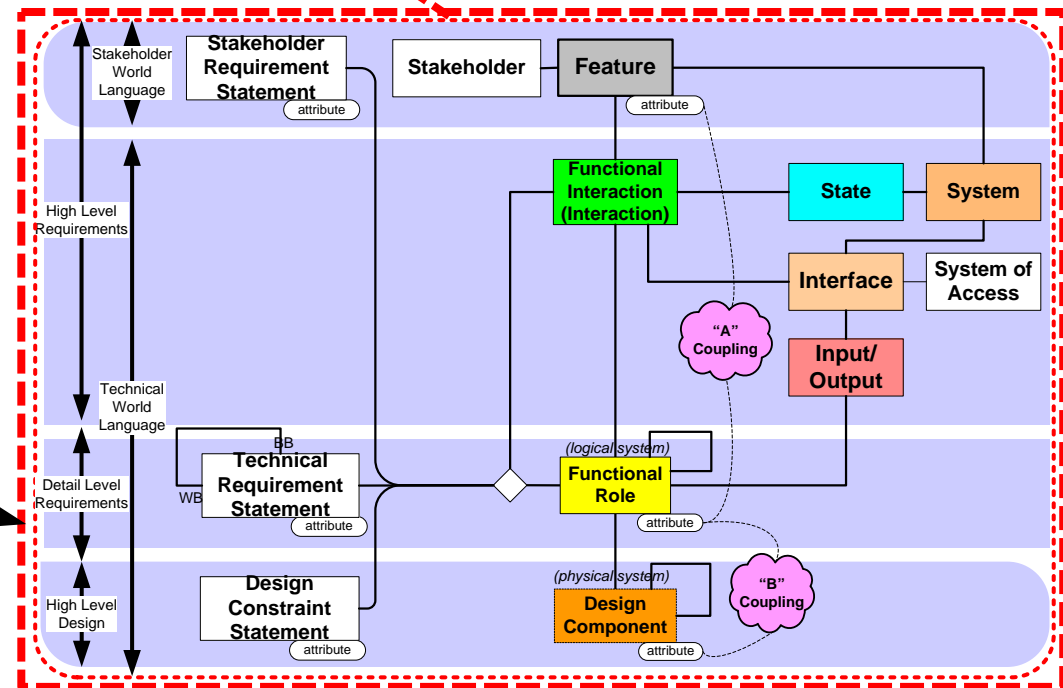

V&V of configurable, reusable models (e.g., S*Patterns) has even greater impact economically, esp. in regulated (think FAA, FDA) markets.

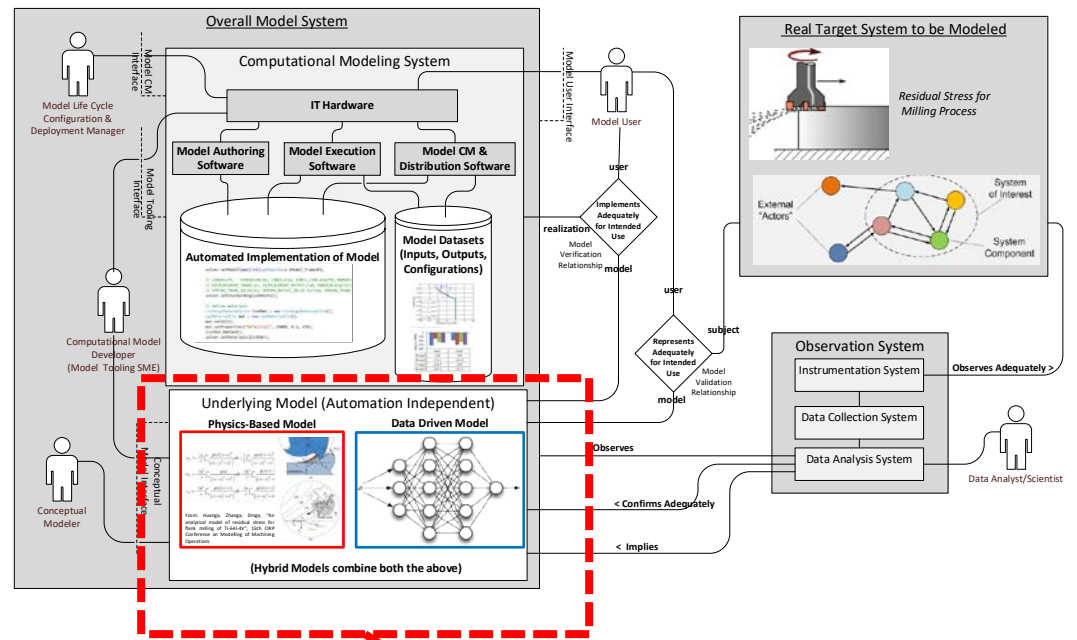

S*Pattern Hierarchy for Pattern-Based Systems Engineering (PBSE)

S*Metamodel for Model-Based Systems Engineering (MBSE)

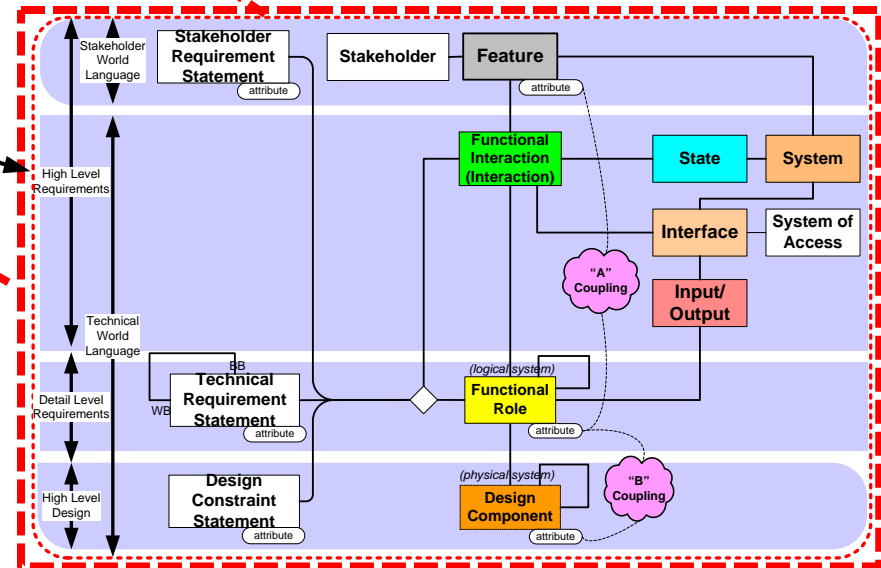
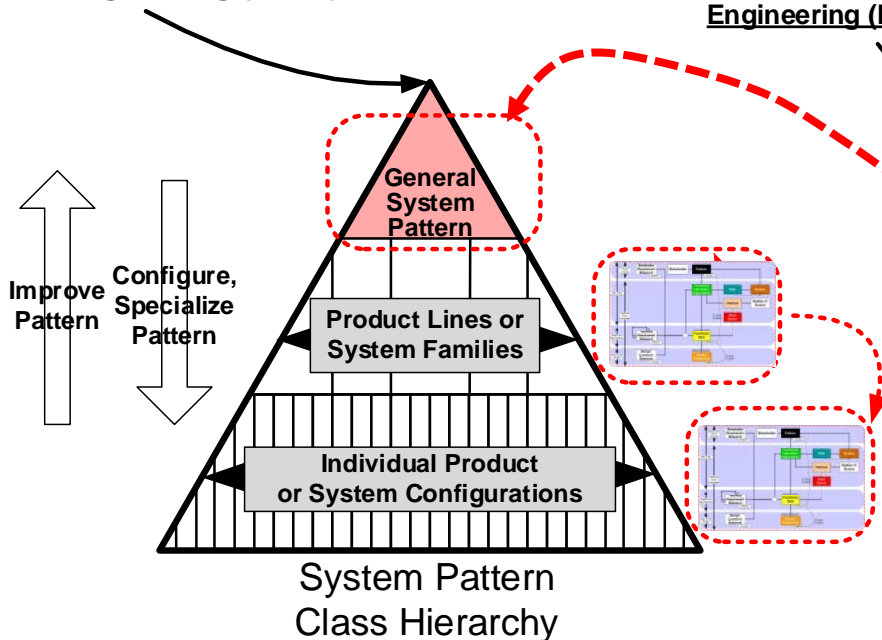

Quantitative Fidelity, including Uncertainty Quantification (UQ)

- There is a large body of literature on a mathematical subset of the UQ problem, in ways viewed as the heart of this work.
- But, some additional systems work is needed, and in progress, as to the more general VVUQ framework, suitable for general standards or guidelines.

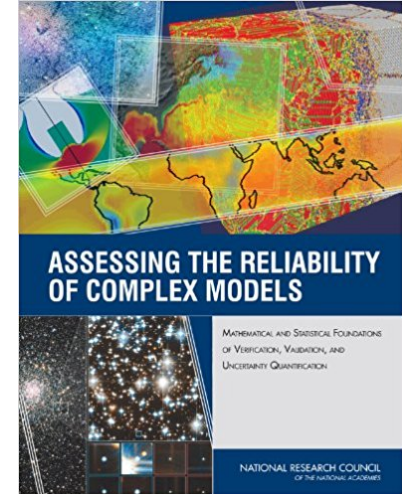

General structure of uncertainty / confidence tracing:

- Do the modeled external Interactions qualitatively cover the modeled Stakeholder Features over the range of intended S1 situations of interest?
- Quantify confidence / uncertainty that the modeled Stakeholder Feature Attributes quantitatively represent the real system concerns of the S1 Stakeholders with sufficient accuracy over the range of intended situation envelopes.
- Quantify confidence / uncertainty that the modeled Technical Performance Attributes quantitatively represent the real system external behavior of the S1 system with sufficient accuracy over the range of intended situation envelopes.

Related activities, communities

- ASME Computational Model V&V Committee / Working Groups:
 - V&V 10: Verification & Validation in Computational Solid Dynamics
 - V&V20: Verification & Validation in Computational Fluid Dynamics and Heat Transfer
 - V&V 30: Verification and Validation in Computational Simulation of Nuclear System Thermal Fluids Behavior
 - V&V 40: Verification and Validation in Computational Modeling of Medical Devices
 - V&V 50: Verification & Validation of Computational Modeling for Advanced Manufacturing
 - V&V 60: Verification and Validation in Modeling and Simulation in Energy Systems and Applications
- INCOSE:
 - Model-Based Engineering Transformation Initiative
 - INCOSE-NAFEMS Joint Working Group on Simulation
 - MBSE Patterns Working Group
 - Risk Management Working Group
 - Decision-Management Working Group
 - Tools Interoperability and Model Life Cycle Management Group
 - INCOSE-OMG MBSE Initiative

Opportunities--what you can do

- INCOSE community can learn from ASME efforts, about model V&V
- ASME community can learn from INCOSE, about systems-level models
- Other professional societies also have an interest at stake in this work
- Engineering professional societies (more than trade groups) are in a good position to collaborate between regulators (e.g., FDA, FAA, etc.) and enterprises/trade groups, as ethical advocates for effective model V&V practice
- How is this related to your enterprise and your own interests?
- Do you need to trust models? What models? From suppliers? For Customers? Others?
- Help is needed in this effort—join our communities and effort, or at least give us feedback

References

1. Assessing the Reliability of Complex Models: Mathematical and Statistical Foundations of Verification, Validation, and Uncertainty Quantification ISBN 978-0-309-25634-6 THE NATIONAL ACADEMIES PRESS, <http://nap.edu/13395>
2. Web site of ASME VV50
<https://cstools.asme.org/csconnect/CommitteePages.cfm?Committee=100003367>
3. “ASME V&V 10-2006: Guide for Verification and Validation in Computational Solid Mechanics”, ASME, 2006.
4. “ASME V&V 20-2009: Standard for Verification and Validation in Computational Fluid Dynamics and Heat Transfer”, ASME, 2009.
5. “ASME V&V 10.1-2012: An Illustration of the Concepts of Verification and Validation in Computational Solid Mechanics”, ASME, 2012.
6. *Journal of Verification, Validation, and Uncertainty Quantification*, ASME.
<https://verification.asmedigitalcollection.asme.org/journal.aspx>
7. AIAA (American Institute for Aeronautics and Astronautics). 1998. *Guide for the Verification and Validation of Computational Fluid Dynamics Simulations*. Reston, Va.: AIAA.
8. Box, G., and N. Draper. *Empirical Model Building and Response Surfaces*. New York: Wiley, 1987.

References, continued

9. Hightower, Joseph, “Establishing Model Credibility Using Verification and Validation”, INCOSE MBSE Workshop, IW2017, Los Angeles, January, 2017.
http://www.omgwiki.org/MBSE/lib/exe/fetch.php?media=mbse:incose_mbse_iw_2017:models_and_uncertainty_in_decision_making_rev_a.pptx
10. Beihoff, B., et al, “A World in Motion: INCOSE Vision 2025”, INCOSE.
11. Schindel, W., “What Is the Smallest Model of a System?”, Proc. of the INCOSE 2011 International Symposium, International Council on Systems Engineering (2011).
12. Schindel, W., and Dove, R., “Introduction to the Agile Systems Engineering Life Cycle MBSE Pattern”, in Proc. of INCOSE 2016 International Symposium, 2016.
13. Schindel, W., “Got Phenomena? Science-Based Disciplines for Emerging Systems Challenges PBSE methodology summary”, Proc. of INCOSE IS2017 Symposium, Adelaide, UK, 2017.
14. Schindel, W., “Requirements Statements Are Transfer Functions: An Insight from MBSE”, Proc. of INCOSE IS2005 Symposium, Rochester, NY, 2005.
15. INCOSE MBSE Initiative Patterns Working Group web site, at
<http://www.omgwiki.org/MBSE/doku.php?id=mbse:patterns:patterns>
16. INCOSE Patterns Working Group, “MBSE Methodology Summary: Pattern-Based Systems Engineering (PBSE), Based On S*MBSE Models”, V1.5.5A, retrieve from:
<http://www.omgwiki.org/MBSE/doku.php?id=mbse:pbse>

Today's Presentation

Things to Think About

How can this be applied in your work environment?

What did you hear that will influence your thinking?

What is your take away from this presentation?

Please

The link for the online survey for this meeting is

www.surveymonkey.com/r/2017_04_MeetingEval

www.surveymonkey.com/r/2017_04_MeetingEval

Look in GlobalMeet chat box for cut & paste link.

Slide presentation can be downloaded now/anytime from:

The library page at: www.incose.org/enchantment.

Recording will be there in the library tomorrow.